

I enlarged view

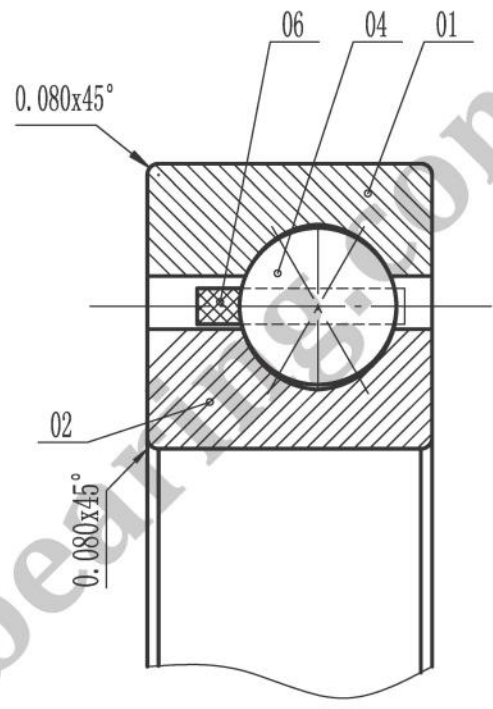

INA THIN SECTION BEARING

Formal drawing of CSXG050 will be submitted after contact with:  
[sales@jcb-bearing.com](mailto:sales@jcb-bearing.com) or [sales@thinsectionbearings.com](mailto:sales@thinsectionbearings.com)

06	cage		Brass				
04	steel ball		AISI 52100 Steel				
02	inner ring	1	AISI 52100 Steel				
01	outer ring	1	AISI 52100 Steel				
NO.	designation	qty.	material	unit	total	remark	
				weight (lbs)			
Luoyang JCB Bearing Technology Co., Ltd Contact information Company Address : No.285 Fenghua road, Luoyang, Henan,China. Postal code : 471000 Phone : 0086-379-68611678 Fax : 0086-379-68611679 E-mail: <a href="mailto:sales@jcb-bearing.com">sales@jcb-bearing.com</a> Reserved E-mail: <a href="mailto:sales@thinsectionbearings.com">sales@thinsectionbearings.com</a> Website: <a href="http://www.jcb-bearing.com">http://www.jcb-bearing.com</a> <a href="https://www.thinsectionbearings.com">https://www.thinsectionbearings.com</a>				<b>CSXG050</b>			
						weight (lbs)	
						4.3	
				total page 1		page 1	
				Luoyang JCB Bearing Technology Co., Ltd			